



	<p><b>Anelli di trascinamento</b> <i>Clutch drive rings</i> Mitnehmerringe DIN 6366 <i>Bagues d'entraînement</i></p>	<p>Pag. - Seite <b>1</b></p>
	<p><b>Viti a croce</b> <i>Cross retaining screws</i> Fräseranzugschrauben DIN 6367 <i>Vis de serrage</i></p> <p><b>Chiavi per viti a croce</b> <i>Cross spanners</i> Spannschlüssel DIN 6368 <i>Clés de serrage</i></p>	<p>Pag. - Seite <b>1</b></p>
	<p><b>Viti di bloccaggio frese - Chiave esagonale</b> <i>Screws for shell end mill holders with exagonal socket</i> Fräseranzugschrauben mit Innensechskant <i>Vis de serrage avec clé six pans</i></p>	<p>Pag. - Seite <b>1</b></p>
	<p><b>Tasselli di trascinamento</b> <i>Drive Key</i> Mitnehmersteine für Quernutfräserdorne <i>Entraineur</i></p>	<p>Pag. - Seite <b>2</b></p>
	<p><b>Ricambi per riduzioni a CM per frese</b> <i>Spare parts for screwed MT mill adapters</i> Zubehoer für Zwischenhülsen <i>Pièces de rechange pour douilles CM</i></p>	<p>Pag. - Seite <b>2</b></p>
	<p><b>Viti per mandrini tipo Weldon e Whistle Notch</b> <i>End mill set screws</i> Spannschraube DIN 1835-B <i>Vis de serrage Weldon et Whistle Notch</i></p>	<p>Pag. - Seite <b>2</b></p>
	<p><b>Vite di arresto per portapinzze</b> <i>Preset screws for collet chucks</i> Verstellbarer Anschlagsschraube für Zangenfutt. <i>Butée de réglage pour mandrins à pince</i></p>	<p>Pag. - Seite <b>3</b></p>
	<p><b>Tamponi pulitori delle sedi portautensili</b> <i>Spindle taper wipers</i> Spindelreiniger <i>Nettoie-broche</i></p>	<p>Pag. - Seite <b>3</b></p>



**Pulitori dei coni esterni HSK 63**  
*External cleaner for HSK 63 tooling*  
**Reiniger für HSK 63 Spannwerkzeuge**  
*Nettoie-cône extérieur pour mandrins HSK 63*

**Pag. - Seite**

**3**



**Tenoni riportati per attacchi a Cono Morse**  
*Removable tangs for Morse Taper Shanks*  
**Austriblappen**  
*Tenons pour CM*

**Pag. - Seite**

**3**



**Anelli di protezione per coni DIN 2080**  
*Safety plastic rings*  
**Schutzring für Steilkegel DIN 2080**  
*Anneaux de protection pour cônes SA*

**Pag. - Seite**

**3**



**Chiave di serraggio a rulli bidirezionali**  
*Clamping spanner with double-way clutch*  
**Rollenschlüssel**  
*Clés de serrage à galets*

**Pag. - Seite**

**4**

# 21 Ricambi - Accessories

CAFORALI

**Anelli di trascinamento**  
*Clutch drive rings*  
 Mitnehmerringe DIN 6366  
*Bagues d'entraînement*

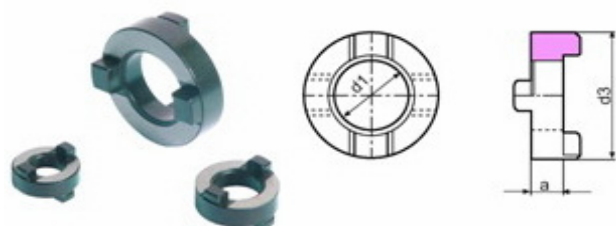

Ref.	Order Nr.	d3	a	Price
401-101	ATR.D16	32	10	
	ATR.D22	40	12	
	ATR.D27	48	12	
	ATR.D32	58	14	
	ATR.D40	70	14	
	ATR.D50	90	16	

**Viti a croce**  
*Cross retaining screws*  
 Fräseranzugschrauben DIN 6367  
*Vis de serrage*



Ref.	Order Nr.	Arbor	d2	Price
401-103	VTC.M6	13	17	
	VTC.M8	16	20	
	VTC.M10	22	28	
	VTC.M12	27	35	
	VTC.M16	32	42	
	VTC.M20	40	52	

**Chiavi per viti a croce**  
*Cross spanners*  
 Spannschlüssel DIN 6368  
*Clés de serrage*



Ref.	Order Nr.	Screw	Price
401-105	SP13C	M6	
	SP16C	M8	
	SP22C	M10	
	SP27C	M12	
	SP32C	M16	
	SP40C	M20	
	SP50C	M24	



**Viti di bloccaggio frese - Chiave esagonale**  
*Screws for shell end mill holders with exagonal socket*  
 Fräseranzugsehrauben mit Innensechskant  
*Vis de serrage avec clé six pans*

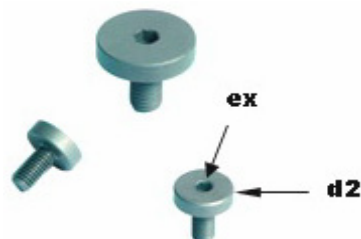

Ref.	Order Nr.	Arbor	d2	ex	Price
401-107	VTF.M6	13	17	5	
	VTF.M8	16	20	6	
	VTF.M10	22	28	8	
	VTF.M12	27	35	10	
	VTF.M16	32	42	12	
	VTF.M20	40	52	14	

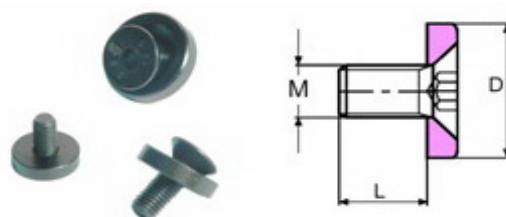

Ref.	Order Nr.	Arbor	D	Price
401-109	VTR.M8	16	20	
	VTR.M10	22	28	
	VTR.M12	27	35	
	VTR.M16	32	42	
	VTR.M20	40	52	



Ref.	Order Nr.	Arbor	d2	Price
401-111	VTS.M8	16	20	
	VTS.M10	22	28	
	VTS.M12	27	35	
	VTS.M16	32	42	
	VTS.M20	40	52	

**CARATTERISTICHE delle viti VTS:**

- Il passo differente dei due filetti ( vite e ghiera ) moltiplica notevolmente la forza di serraggio sull'utensile.

**FEATURES of VTS screws**

- Very high clamping power on the cutting tool due to the two different pitch of the ring and the screw.



## Tasselli di trascinamento

Drive Key

Mitnehmersteine für Quernutfräserdorne

Entraîneur

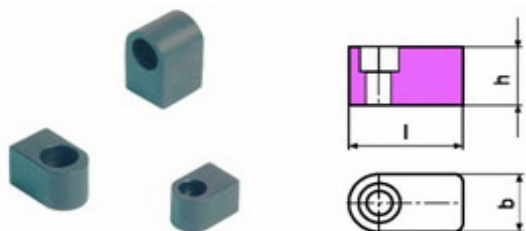

Ref.	Order Nr.	b x h x l	Price *
401-115	TTR8 (D13-16)	8 x 8 x 14	
	TTR10 (D22)	10 x 10 x 18	
	TTR12 (D27)	12 x 12 x 18	
	TTR14 (D32)	14 x 14 x 22	
	TTR16 (D40)	16 x 16 x 25	

\* **Prezzo unitario - Unit price**

## Ricambi per riduzioni a CM per frese

Spare parts for screwed MT mill adapters

Zubehoer für Zwischenhülsen

Pièces de rechange pour douilles CM



Ref.	Order Nr.	Adapt.	Price
401-120	<b>Anello / Ring + Vite / Screw</b>		
	AN40-MT1FV.M6	SK40	
	AN40-MT2FV.M10	SK40	
	AN40-MT3FV.M12	SK40	
	AN40-MT4FV.M16	SK40	
	AN50-MT1FV.M6	SK50	
	AN50-MT2FV.M10	SK50	
	AN50-MT3FV.M12	SK50	
	AN50-MT4FV.M16	SK50	
	AN50-MT5FV.M20	SK50	

### Chiavi - Spanners

UB40-MT1FV  
UB40-MT2FV  
UB40-MT3FV  
UB40-MT4FV

UB50-MT1FV  
UB50-MT2FV  
UB50-MT3FV  
UB50-MT4FV  
UB50-MT5FV

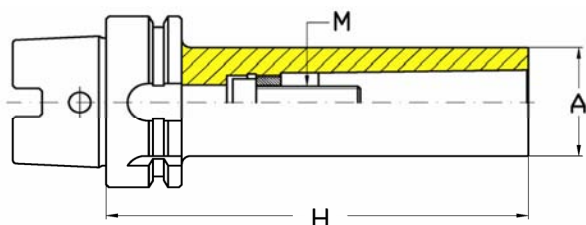

## Viti per mandrini tipo Weldon e Whistle Notch

End mill set screws

Spannschraube DIN 1835-B

Vis de serrage Weldon et Whistle Notch



Ref.	Order Nr.	Weldon	Price
401-125	WE.M6x10	WE6	
	WE.M8x10	WE8	
	WE.M10x10	WE10	
	WE.M10x12	WE10	
	WE.M12x10	WE12-14	
	WE.M12x16	WE12-14	
	WE.M14x10	WE16-18	
	WE.M14x16	WE16-18	
	WE.M16x10	WE25-32	
	WE.M16x14	WE20	
	WE.M16x16	WE20-22	
	WE.M18x2x20	WE25-32	
	WE.M20x2x20	WE32-40	
	WE.M24x2x25	WE50	

## Viti per mandrini Whistle Notch, con sfera

End mill screws with half ball

Spannschraube mit Kugel

Vis de serrage avec bille



Ref.	Order Nr.	Whistle-Notch	Price
401-127	WHN.M6x10	WHN6	
	WHN.M8x10	WHN8	
	WHN.M10x12	WHN10	
	WHN.M12x16	WHN12-14	
	WHN.M14x16	WHN16-18	
	WHN.M16x16	WHN20	
	WHN.M18x2x20	WHN25	
	WHN.M20x2x20	WHN32-40	

Consentono di montare le frese Whistle Notch sui mandrini Weldon

For mounting the end mill with a 2° angled flat shank on Weldon Holders

# 21 Ricambi - Accessories

CAFORALI

Vite di arresto per portapinzine  
*Preset screws for collet chucks*  
 Verstellbarer Anschlagsschraube für Zangenfutt.  
*Butée de réglage pour mandrins à pince*

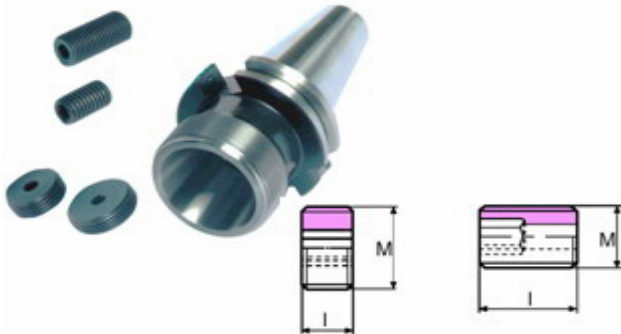

Ref.	Order Nr.	Foro-Hole	Collet	Price
401-135	SW.M6x1x16	—	ERC11	
	SW.M8x1,25x40	—	ERC16-20	
	SW.M10x1,5x16	—	ERC16	
	SW.M12x1,75x16	—	ERC20	
	SW.M14x1,5x40	—	ERC25-32	
	SW.M18x1,5x8	5	ERC25	
	SW.M22x1,5x8	5	ERC32-40	
	SW.M27x1,5x8	5	ERC40	
	SW.M27x1,5Sx8	5	ETG100	

**Le viti di arresto M10 - 12 - 14 con foro, sono fornibili a richiesta**

Tamponi pulitori delle sedi portautensili  
*Spindle taper wipers*  
 Spindelreiniger  
*Nettoie-broche*



Ref.	Order Nr.	Tapers	Price
401-140	TCL1MT	Morse 1	
	TCL2MT	Morse 2	
	TCL3MT	Morse 3	
	TCL4MT	Morse 4	
	TCL5MT	Morse 5	
	TCL30	SK 30	
	TCL40	SK40	
	TCL45	SK45	
	TCL50	SK 50	
	TCL32HSK	HSK32A	
	TCL40HSK	HSK40A	
	TCL50HSK	HSK50A	
	TCL63HSK	HSK63A	
	TCL80HSK	HSK80A	
	TCL100HSK	HSK100A	

Pulitori dei coni esterni HSK 63  
*External cleaner for HSK 63 tooling*  
 Reiniger für HSK 63 Spannwerkzeuge  
*Nettoie-cône extérieur pour mandrins HSK 63*

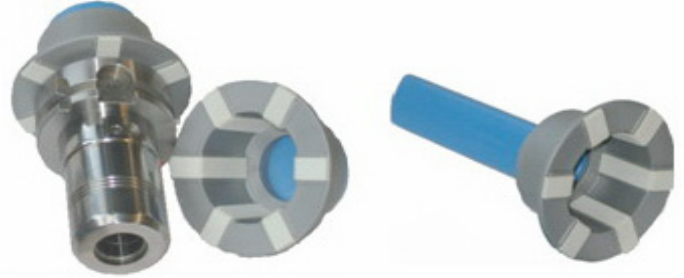

Fig. 1

Fig. 2

Ref.	Order Nr.	Fig.	Taper	Price
401-143	TCL63 EX	1	HSK 63A	
	TCL63 EXH	2	HSK 63A	

Tenoni riportati per attacchi a Cono Morse  
*Removable tangs for Morse Taper Shanks*  
 Austrablappen  
*Tenons pour CM*



Ref.	Order Nr.	Morse	Price
401-145	TAG1-M6	1	
	TAG2-M10	2	
	TAG3-M12	3	
	TAG4-M16	4	
	TAG5-M20	5	

Anelli di protezione per coni DIN 2080  
*Safety plastic rings*  
 Schutzring für Steilkegel DIN 2080  
*Anneaux de protection pour cônes SA*

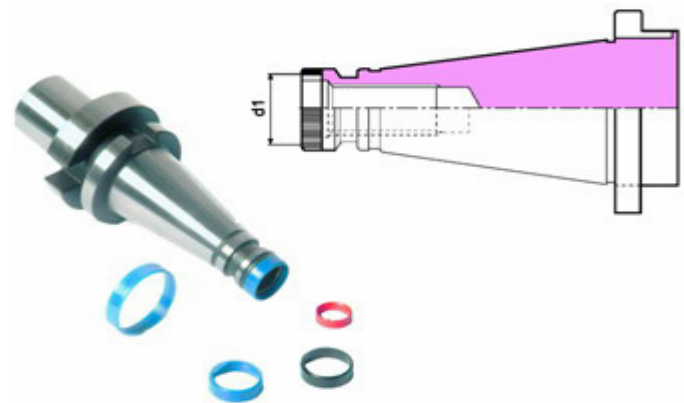

Ref.	Order Nr.	d1	Price
401-150	RING40	22,6	
	RING50	36,2	

Chiave di serraggio a rulli bidirezionali  
*Clamping spanner with double-way clutch*  
 Rollenschlüssel  
*Clés de serrage à galets*

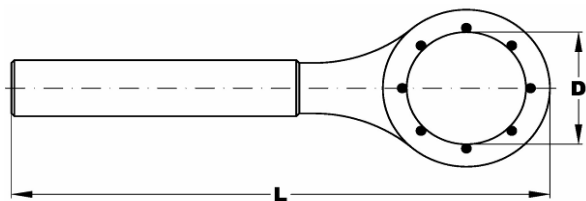

Ref.	Order Nr.	Ghiera - Nut Mutter - Écrou	D	L	Price
401-200	SP12RLM	<b>NF8 Mini</b>	12	130	
	SP16RLM	<b>NF11 Mini</b>	16	130	
	SP18RLM	<b>Speciale</b>	18	130	
	SP22RLM	<b>Speciale</b>	22	130	
	SP24RLM	<b>NF16M - NF16DM</b>	24	130	
	SP28RLM	<b>Speciale</b>	28	150	
	SP30RLM	<b>NF20M - NF20DM</b>	30	150	
	SP32RLM	<b>NF16 - NF16D</b>	32	150	
	SP35RLM	<b>NF20 - NF20D</b>	35	150	
	SP37RLM	<b>NF25M - NF25DM</b>	37	150	
	SP42RLM	<b>NF25 - NF25D - NF16 GOC</b>	42	180	
	SP50RLM	<b>NF32 - NF32D</b>	50	220	
	SP63RLM	<b>NF40 - NF40D - NF25 GOC</b>	63	250	
	SP72RLM	<b>NF32 GOC</b>	72	270	

